



M-Series® M7600

Electromagnetic Flow Meter



Available from:  **STERLING
CONCRETE
EQUIPMENT** 937-747-4300
SterlingConcreteEquipment.com



MAG-UM-00507-EN-01 (May 2016)

User Manual

Available from:



**STERLING
CONCRETE
EQUIPMENT**

937-747-4300

SterlingConcreteEquipment.com

CONTENTS

Scope of This Manual	5
Safety Precautions and Instructions.	5
System Description	5
Unpacking and Inspection	6
Rigging, Lifting and Moving Large Units	6
Meter Location, Orientation and Applications	7
Meter Mount Configuration	7
Temperature Ranges	7
Pipelines and Fluid Flow	7
Meter Orientation	8
Straight Pipe Requirements	8
Pipe Reducer Requirements.	9
Chemical Injection Applications	9
Partially-Filled Pipe Situations.	10
Meter Gaskets and Grounding	11
Meter/Pipeline Connection Gaskets.	11
Meter Grounding	11
Conductive Pipe Grounding.	11
Pipelines with Cathodic Protection	11
Power Connections	12
Wiring Safety	12
Opening the Cover.	12
Power Supply Connections	13
Configuring Input/Output (I/O).	14
Wiring to a PC-200 Controller	15
Wiring to an ER-10 Industrial Register.	15
Menu Programming Options	16
Screen Layout.	16
Function Buttons.	16
M7600 Menu	17
Maintenance	18
Cleaning the Flow Tube and Electrode	18
Specifications.	19
Performance.	19

Materials of Construction 19

Inputs 19

Outputs 19

Approvals 19



Available from:  **STERLING
CONCRETE
EQUIPMENT** 937-747-4300
SterlingConcreteEquipment.com

SCOPE OF THIS MANUAL

This manual contains information concerning the installation, operation and maintenance of the Badger Meter® M-Series M7600 electromagnetic flow meter. Read and understand the instructions given in this manual. Retain this manual in a readily accessible location for future reference.

SAFETY PRECAUTIONS AND INSTRUCTIONS

Some procedures in this manual require special safety considerations. In such cases, the text is emphasized with the following symbols:

Symbol	Explanation
	Warning indicates the potential for severe personal injury, death or substantial property damage. Comply with the instructions and proceed with care.
	Caution indicates the potential for minor personal injury or property damage. Comply with the instructions and proceed with care.

SYSTEM DESCRIPTION

The Badger Meter M7600 electromagnetic flow meter successfully combines the most advanced electromagnetic flow metering technology with the simplicity and ruggedness of the Badger Meter proven Batching Systems for Industrial Applications.

The M7600 meter is intended for fluid metering in most industries including water, wastewater, food and beverage, pharmaceutical, chemical and concrete.

The basic components of an electromagnetic flow meter are:

- The **detector**, which includes the flow tube, isolating liner and measuring electrodes.
- The **amplifier**, which is the electronic device responsible for the signal processing, flow calculation, display and output signals.

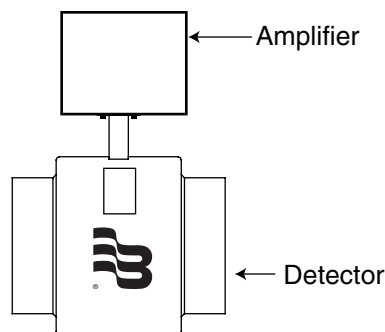


Figure 1: Amplifier and Detector

The construction materials of the wetted parts (liner and electrodes) should be appropriate for the specifications on the intended type of service. We recommend that you review all of the compatibilities consistent with the specifications.

Each meter is factory tested and calibrated. A calibration certificate is included with each meter.

UNPACKING AND INSPECTION

Follow these guidelines when unpacking the M-Series equipment.

- If a shipping container shows any sign of damage, have the shipper present when you unpack the meter.
- Follow all unpacking, lifting and moving instructions associated with the shipping container.
- Open the container and remove all packing materials. Store the shipping container and packing materials in the event the unit needs to be shipped for service.
- Verify that the shipment matches the packing list and your order form.
- Inspect the meter for any signs of shipping damage, scratches, or loose or broken parts.

NOTE: If the unit was damaged in transit, it is your responsibility to request an inspection report from the carrier within 48 hours. You must then file a claim with the carrier and contact Badger Meter for appropriate repairs or replacement.

- All detectors are shipped with a liner protector on each end to maintain proper form of the polytetrafluoroethylene (PTFE) material during shipping and storage.

NOTE: Do not remove the liner protectors until you are ready to install.

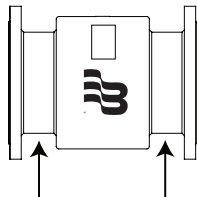
- Storage: If the meter is to be stored, place it in its original container in a dry, sheltered location. Storage temperature ranges are: $-22 \dots 158^{\circ}\text{F}$ ($-30 \dots 70^{\circ}\text{C}$).

Rigging, Lifting and Moving Large Units

CAUTION

WHEN RIGGING, LIFTING OR MOVING LARGE UNITS, FOLLOW THESE GUIDELINES:

- DO NOT lift or move a meter by its amplifier, junction box, detector neck, or cables.
- Use a crane rigged with soft straps to lift and move meters with flow tubes that are between two inches and four inches (50 mm and 100 mm). Place the straps around the detector body, between the flanges, on each side of the detector.



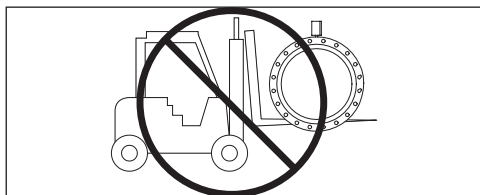
Place straps between flanges.

Figure 2: Rigging Large Units

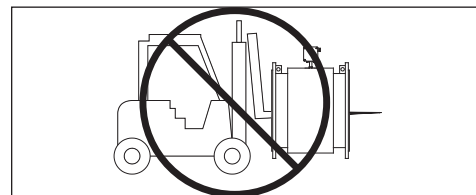


Figure 3: Sling-Rigged Lifting Methods

- Use the sling-rigged method to lift large detectors into a vertical position while they are still crated. Use this method to position large detectors vertically into pipelines.
- Do not lift a detector with a forklift by positioning the detector body on the forks, with the flanges extending beyond the lift. This could dent the housing or damage the internal coil assemblies.
- Never place forklift forks, rigging chains, straps, slings, hooks or other lifting devices inside or through the detector's flow tube to hoist the unit. This could damage the isolating liner.



Do not lift detector with forklift.



Do not lift or rig lifting devices through detector.

Figure 4: Lifting and Rigging Cautions

METER LOCATION, ORIENTATION AND APPLICATIONS

Meter Mount Configuration

The meter mount configuration has the amplifier mounted directly on the detector. This compact, self-contained configuration minimizes installation wiring.

Temperature Ranges

⚠ CAUTION

TO PREVENT DAMAGE TO THE METER, STRICTLY OBSERVE THE AMPLIFIER'S AND DETECTOR'S MAXIMUM TEMPERATURE RANGES.

In regions with extremely high ambient temperatures, protect the detector.

Amplifier	Ambient temperature	- 4...140° F (-20...60° C)
Detector (PTFE)	Fluid temperature	- 40...212° F (- 40...100° C)

Pipelines and Fluid Flow

Take the following precautions during installation:

- Do not install the meter on pipes with extreme pipe vibrations. If pipes are vibrating, secure the piping with appropriate pipe supports in front of and behind the meter.
- Do not install the meter close to pipeline valves, fittings or impediments that can cause flow disturbances.
- Do not install the meter on suction sides of pumps.
- Do not install the meter on outlet sides of piston or diaphragm pumps. Pulsating flow can affect meter performance.
- Avoid installing the meter near equipment that produces electrical interference such as electric motors, transformers, variable frequency, and power cables.
- Verify that both ends of the signal cables are securely fastened.
- Place power cables and signal cables in separate conduits.
- Place the meter where there is enough access for installation and maintenance tasks.

Available from:



**STERLING
CONCRETE
EQUIPMENT**

937-747-4300

SterlingConcreteEquipment.com

Meter Orientation

Mag meters can operate accurately in any pipeline orientation and can measure volumetric flow in forward and reverse directions.

NOTE: A "Forward Flow" direction arrow is printed on the detector label.

Vertical Placement

Mag meters perform best when placed vertically, with liquid flowing upward and meter electrodes in a closed, full pipe. Vertical placement allows the pipe to remain completely full, even in low flow, low pressure applications, and it prevents solids build-up, sediment deposit and accumulation on the liner and electrodes.

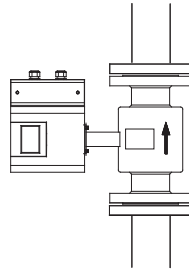


Figure 5: Vertical placement

Horizontal Placement

The M7600 meters are equipped with an *Empty Pipe Detection* feature. If an electrode mounted in the pipe is not covered by fluid for five seconds, the meter will display an Empty Pipe Detection condition. The meter will send out an error message and stop measuring flow. When the electrode is again covered with fluid, the error message disappears and the meter will begin measuring.

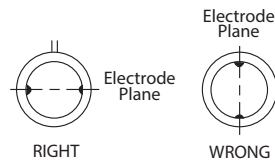


Figure 6: Horizontal placement

When installing the meter on a horizontal pipe, mount the detector to the pipe with the flow-measuring electrode axis in a horizontal plane (three and nine o'clock). This placement helps prevent solids build-up, sediment deposit and accumulation on the electrodes.

Straight Pipe Requirements

Sufficient straight-pipe runs are required at the detector inlet and outlet for optimum meter accuracy and performance. An equivalent of three diameters of straight pipe is required on the inlet (upstream) side. Two diameters are required on the outlet (downstream) side.

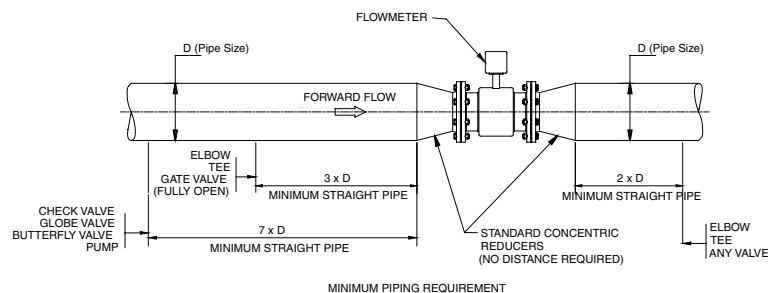


Figure 7: Straight pipe requirements

Pipe Reducer Requirements

With pipe reducers, a smaller meter can be mounted in larger pipelines. This arrangement may increase low-flow accuracy. There are no special requirements for standard, concentric, pipe reducers.

Custom fabricated pipe reducers must have an approximate slope angle of 15 degrees to minimize flow disturbances and excessive loss of head. If this is not possible, install the custom pipe reducers as if they were fittings and install the required amount of straight pipe

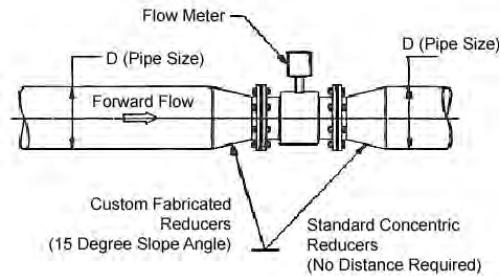


Figure 8: Pipe reducer requirements

Chemical Injection Applications

For water line applications with a chemical injection point, install the meter upstream of the injection point. This eliminates any meter performance issues.

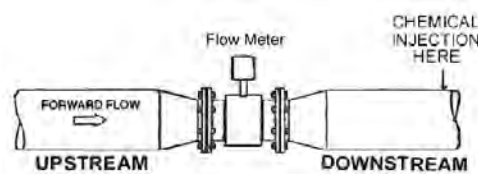


Figure 9: Chemical injection point upstream of meter

If a meter must be installed downstream of a chemical injection connection, the distance between the meter and the injection point should be between 50 and 100 feet (15 and 30 meters). The distance must be long enough to allow the water or chemical solution to reach the meter in a complete, homogeneous mixture.

If the injection point is too close, the meter senses the two different conductivities for each liquid. This will likely result in inaccurate measurements. The injection method—spaced bursts, continuous stream of drips or liquid or gas—can also affect downstream readings by the meter.

Partially-Filled Pipe Situations

In some locations, the process pipe may be momentarily only partially filled. Examples include: lack of back pressure, insufficient line pressure and gravity flow applications.

To eliminate these situations:

- Do not install the meter at the highest point of the pipeline.
- Do not install the meter in a vertical, downward flow section of pipe.
- Always position the ON/OFF valves on the downstream side of the meter.

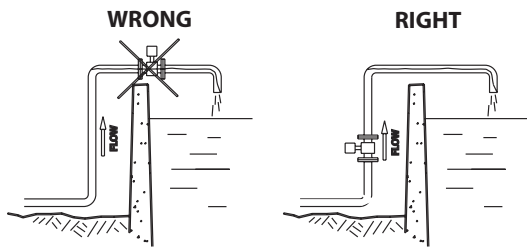
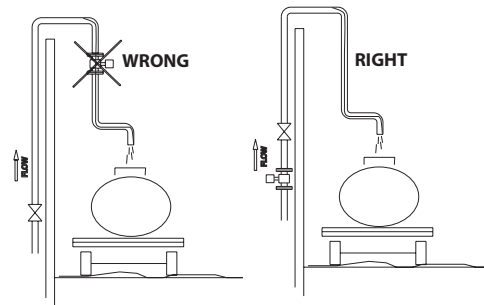


Figure 10: Incorrect meter placement



Do not install in a vertical, downward position.

Position "On/Off" valves on downstream side.

Figure 11: Position valves on downstream side

To minimize the possibility of partially-full pipe flows in horizontal, gravity or low pressure applications, create a pipe arrangement that ensures the detector remains full of liquid at all times.

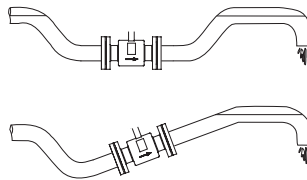


Figure 12: Pipe positioned to keep water in detector

Available from:



**STERLING
CONCRETE
EQUIPMENT**

937-747-4300

SterlingConcreteEquipment.com

METER GASKETS AND GROUNDING

Gasket and grounding requirements must be considered when determining the meter location, orientation and application. Grounding rings are provided with the M7600 meter.

Meter/Pipeline Connection Gaskets

You must install gaskets (provided) between the detector's isolating liner and the pipeline flange to ensure a proper and secure hydraulic seal. Use gaskets that are compatible with the fluid. Center each gasket on the flange to avoid flow restrictions or turbulence in the line.

During installation, do not use graphite or any electrically conductive sealing compound to hold the gaskets. This could compromise the accuracy of the measuring signal.

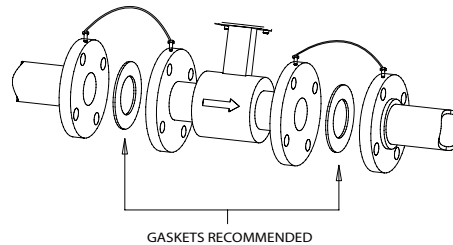


Figure 13: Meter/pipeline connection gaskets

Meter Grounding

Process pipeline material can be either electrically conductive (metal) or not electrically conductive (made of or lined with PVC, fiberglass or concrete).

It is essential that the mag meter amplifier's input ground (zero voltage reference) be electrically connected to the liquid media and to a good, solid earth ground reference.

Conductive Pipe Grounding

To achieve an adequate ground, the meter body **MUST** be electrically connected to the liquid media. The mag meter flanges are provided with grounding bolts for this purpose.

If the pipe material is electrically conductive, simply install grounding straps between these grounding bolts and the mating flanges.

To ensure a good electrical connection at the mating flanges, we recommend that you drill and tap the flanges and install a grounding screw (not provided).

These grounding straps must be copper wire, at least 12 AWG size. They must be connected on both sides (inlet and outlet) of the detector and to a local, earth ground.

Pipelines with Cathodic Protection

As for pipelines with cathodic protection, install meter potential-free. No electric connection from the meter to the pipeline system may exist and power supply is to be provided via isolating transformer.

CAUTION

GROUNDING RINGS ALSO NEED TO BE INSTALLED ISOLATED FROM THE PIPELINE SYSTEM.

Observe national rules for potential-free installations.

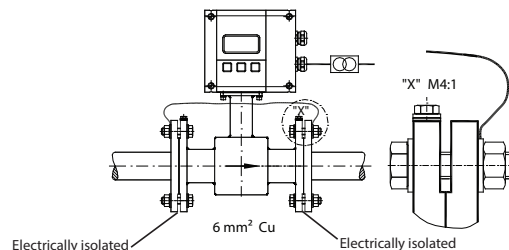


Figure 14: Cathodic protection

POWER CONNECTIONS

Wiring Safety

⚠ WARNING

AT INSTALLATION, BE SURE TO COMPLY WITH THE FOLLOWING REQUIREMENTS:

- Disconnect power to the unit before attempting any connection or service to the unit.
- Do not bundle or route signal lines with power lines.
- Keep all lines as short as possible.
- Use twisted pair shielded wire for all output wiring.
- Observe all applicable local electrical codes.

Opening the Cover

The M7600 amplifier's design lets you open the cover without completely removing it.

Follow these steps:

1. Completely remove the top two screws from the amplifier using a blade/slotted screwdriver.
 2. Loosen both of the bottom screws so that the round head of each screw clears the top face of the cover.
 3. Pull down the cover to the open position.
- For the 2 x M20 cable inlets, use only flexible electric cables.
 - Use separate cable inlets to separate power from signal and input/output cables.



Figure 15: Remove two screws



Figure 16: Open the cover

Available from:



**STERLING
CONCRETE
EQUIPMENT**

937-747-4300

SterlingConcreteEquipment.com

Power Supply Connections

External Disconnect

⚠ CAUTION

- Install an external disconnect switch or circuit breaker that meets local standards.
- Position the M7600 meter in an accessible location.
- Position and identify the disconnect device so as to provide safe and easy operation.
- Label the disconnect device as being for the mag meter.

AC Power Wiring

For the AC power connections, use three wire-sheathed cable with an overall cable diameter of 0.2...0.45 inch (5...12 mm). For signal output, use 18...22 gauge (0.25...0.75 mm²) shielded wire. Overall cable diameter between 0.12...0.35 inch (3...9 mm).

⚠ CAUTION

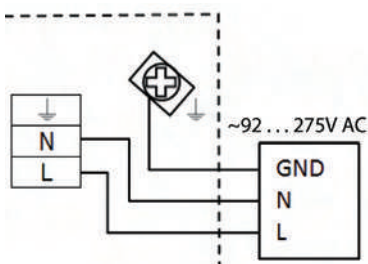
TO PREVENT ACCIDENTS, CONNECT MAIN POWER ONLY AFTER ALL OTHER WIRING HAS BEEN COMPLETED.

The amplifier is a microprocessor device. It is important that the power supply be as "clean" as possible. Avoid using power lines that feed heavy loads: pumps, motors, etc. If dedicated lines are not available, a filtering or isolation system may be required.

Take national applicable rules into account.

- Observe type plate (mains voltage and frequency)
 - Equipment shall be provided with a external means for disconnecting it from each operating energy supply source. The disconnecting means shall disconnect all current-carrying conductors.
1. Open the cover (see "Opening the Cover" on page 12).
 2. Push the power cable through the upper cable inlet.
 3. Connect as shown in Figure 17.
 4. Close the cover and tighten the screws.

Power supply 92...275V AC (50/60 Hz)
Recommended cable size min. 0.75 mm²



Power supply 9...36V DC (max. 9 W)
Recommended cable size min. 0.75 mm²

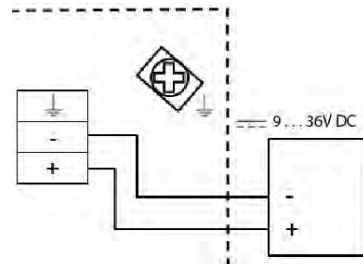


Figure 17: Power connections

Available from:



**STERLING
CONCRETE
EQUIPMENT**

937-747-4300

SterlingConcreteEquipment.com

Configuring Input/Output (I/O)

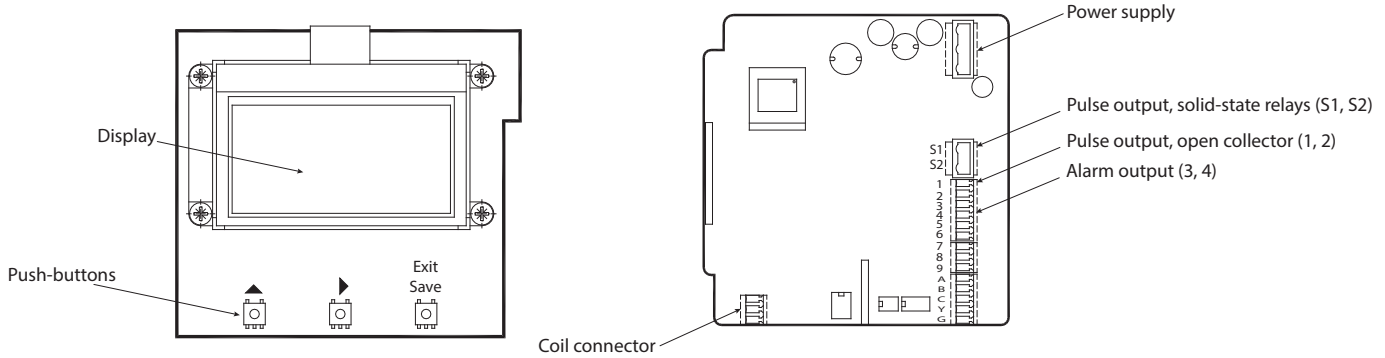


Figure 18: Configuring I/O

Output	Description	Terminal
Pulse Output	Open collector max. 10 kHz	1 and 2
	Passive max. 32V DC, <100 Hz 100 mA, >100 Hz 20 mA	
	Solid-state relays max. 230V AC, 500 mA, max. 1 Hz	S1 and S2
Alarm Output	Open collector	3 and 4
	Passive max. 32V DC, 100 mA	

Table 1: Input/output descriptions

CAUTION

- **USE SEPARATE CABLE INLETS FOR CABLES CONNECTED TO THE SOLID-STATE RELAY OUTPUT AND CABLES CONNECTED TO THE OTHER INPUT/OUTPUTS.**
- **IN MULTIPHASE NETWORKS, SOLID-STATE RELAY SHOULD HANDLE ONLY THE SAME PHASE THAT IS USED FOR POWERING THE METER.**

Connecting the M7600 Meter to 110V AC from Batch Control Panel Power Supply

Typical concrete batch panel.

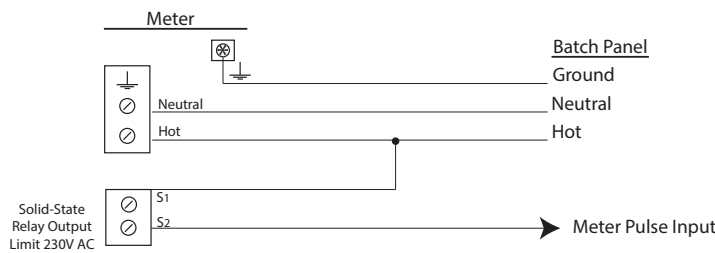


Figure 19: Batch panel power connections

- The connection shown in Figure 19 is for batch panels that require a 115V AC hot pulse for meter signals.
- Consult the batch panel manufacturer to confirm the required pulse signal.
- For a 115V AC neutral pulse signal to the batch panel, take the S2 jumper to the 115 neutral power supply.

CAUTION

DO NOT PASS MORE THAN 230V AC THROUGH THE SOLID-STATE RELAY.

Wiring to a PC-200 Controller

To connect the open collector scaled pulse output from the Model M7600 meter to the PC-200 controller, follow *Figure 20*.

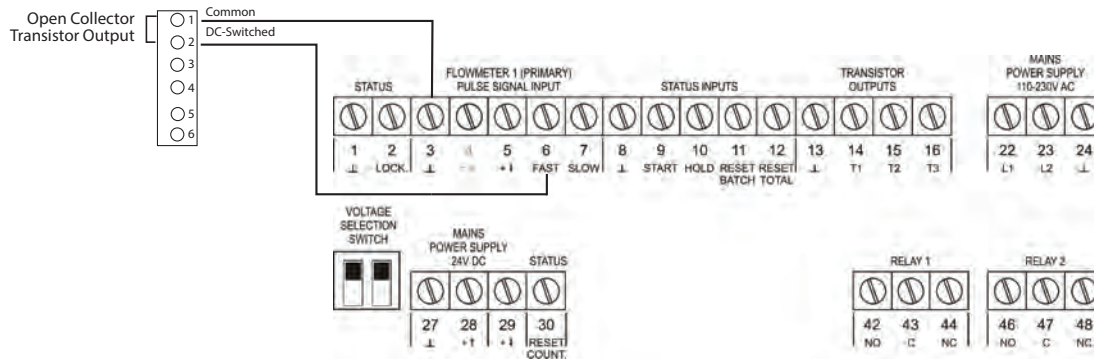


Figure 20: Wiring to a PC-200 controller

Wiring to an ER-10 Industrial Register

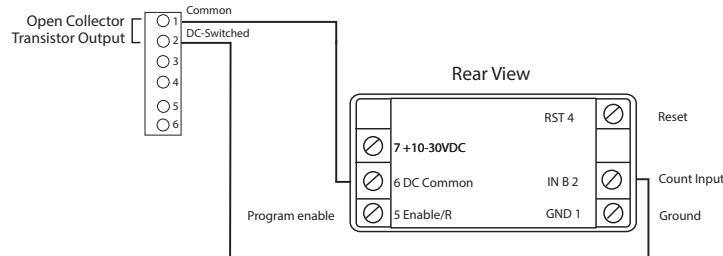


Figure 21: Wiring to an ER-10 register

Terminal	Function	Operation
1	Ground	—
2	Input B Count input	Count input Contact closure of NPN 100 Hz max
3	—	Not used
4	Reset	Connect to ground to reset totalizer. This is a maintained or level-sensitive reset.
5	Program enable	Connect to ground to enter program mode.
6	Backlight common	—
7	Backlight power	Connect to power to light display.

Table 2: ER-10 wiring terminals

Available from:  **STERLING
CONCRETE
EQUIPMENT** 937-747-4300
SterlingConcreteEquipment.com

MENU PROGRAMMING OPTIONS

Screen Layout

The following M7600 meter programming options are available from the *M7600 Menu*:

- *Scale factor*
- *Pulse/unit*
- *Flow unit*
- *Totalizer unit*

Function Buttons

All M7600 programming is accomplished using the three function buttons located on the front of the amplifier. Screen navigation, digit, and parameter selection is performed by pressing a combination of these three buttons.

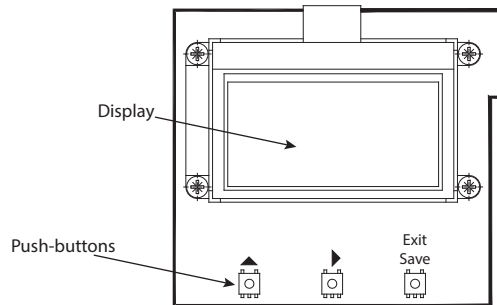


Figure 22: Function buttons

Press the **Exit/Save** button to access the M7600 programming options.





Press the **left button** to scroll through the programming options.

Press the **center button** to edit a programmable option.

For selection list options (for instance, Totalizer Unit or Flow Unit), press the **left button** to change the value. Press the **right button** to confirm the new value.

For numerical options (for instance, Scale Factor or Pulse/Unit), press the **left button** to change the numerical digit value. Press the **center button** to move to the next numerical digit. When all digits are entered, press the **right button** to confirm the new value.

Status Icons

-  Communication interface is activated
-  Meter is unlocked
-  Error message
-  Empty pipe detection

M7600 Menu

<p>Scale Factor</p>	<p>Changing the scale factor lets you adjust the meter's accuracy without disturbing parameters set by the factory. You can tune the meter to meet changing application requirements in a range of $\pm 10\%$ (0.90 to 1.10).</p> <p>If it is necessary to recalibrate the meter, follow these steps:</p> <ol style="list-style-type: none"> 1. Determine the exact quantity of fluid that actually passed through the meter by using a calibrated volumetric container or by weighing the container. 2. Note the volume of fluid indicated by meter. 3. Note the current scale factor on the meter LCD (scale factor menu). 4. Use the following formula to calculate the new scale factor for recalibration: $\frac{\text{Qty delivered}}{\text{Qty on meter}} \times \text{Old scale factor} = \text{New scale factor}$ <ol style="list-style-type: none"> 5. Use the meter push-buttons to enter the new scale factor. 6. Rerun test to verify that the recalibration is correct. <p><i>Example:</i> You have a 3" size meter in your installation. You run a test batch quantity of 210 gallons. The totalizer on the meter indicates 203 gallons. Your present scale factor on the meter is 1.00. Using the formula:</p> $\frac{210}{203} \times 1.0 = 1.03$ <p>Your new scale factor is 1.03.</p>																																								
<p>Pulse/Unit</p>	<p>The Pulses/Unit parameter lets you set how many pulses per unit of measure will be transmitted. The maximum output frequency of 10,000 pulses/sec. 10 kHz must not be exceeded for the Open Collector. 1 Hz must not be exceeded for the Solid-State Relay. If both are used, 1 Hz must not be exceeded.</p> <p>For example, assuming the unit of measure is gallons:</p> <ul style="list-style-type: none"> • Setting the Pulses/Unit to 1 will transmit 1 pulse every gallon • Setting the Pulses/Unit to 0.01 will transmit 1 pulse every 100 gallons <p>You must configure pulses/unit if the function of the selected output is to be open collector or solid-state.</p>																																								
<p>Flow Unit</p>	<p>Flow Units let you select among the Flow Units listed below. Flow units are automatically converted into the selected unit.</p> <table border="1" data-bbox="435 1381 1344 1675"> <thead> <tr> <th><i>Display</i></th> <th><i>Flow Unit</i></th> <th><i>Display</i></th> <th><i>Flow Unit</i></th> </tr> </thead> <tbody> <tr> <td>L/s</td> <td>Liters/Second</td> <td>gal/s</td> <td>Gallons/Second</td> </tr> <tr> <td>L/min</td> <td>Liters/Minute</td> <td>gal/min</td> <td>Gallons/Minute</td> </tr> <tr> <td>L/h</td> <td>Liters/Hour</td> <td>gal/h</td> <td>Gallons/Hour</td> </tr> <tr> <td>m³/s</td> <td>Cubic Meters/Second</td> <td>MG/D</td> <td>MillionGallons/Day</td> </tr> <tr> <td>m³/min</td> <td>Cubic Meters/Minute</td> <td>IG/s</td> <td>ImperialGallons/Second</td> </tr> <tr> <td>m³/h</td> <td>Cubic Meters/Hour</td> <td>IG/min</td> <td>ImperialGallons/Minute</td> </tr> <tr> <td>ft³/s</td> <td>Cubic Feet/Second</td> <td>IG/h</td> <td>ImperialGallons/Hour</td> </tr> <tr> <td>ft³/m</td> <td>Cubic Feet/Minute</td> <td>Oz/min</td> <td>Ounce/Minute</td> </tr> <tr> <td>ft³/h</td> <td>Cubic Feet/Hour</td> <td>bbl/min</td> <td>Barrel/Minute</td> </tr> </tbody> </table>	<i>Display</i>	<i>Flow Unit</i>	<i>Display</i>	<i>Flow Unit</i>	L/s	Liters/Second	gal/s	Gallons/Second	L/min	Liters/Minute	gal/min	Gallons/Minute	L/h	Liters/Hour	gal/h	Gallons/Hour	m ³ /s	Cubic Meters/Second	MG/D	MillionGallons/Day	m ³ /min	Cubic Meters/Minute	IG/s	ImperialGallons/Second	m ³ /h	Cubic Meters/Hour	IG/min	ImperialGallons/Minute	ft ³ /s	Cubic Feet/Second	IG/h	ImperialGallons/Hour	ft ³ /m	Cubic Feet/Minute	Oz/min	Ounce/Minute	ft ³ /h	Cubic Feet/Hour	bbl/min	Barrel/Minute
<i>Display</i>	<i>Flow Unit</i>	<i>Display</i>	<i>Flow Unit</i>																																						
L/s	Liters/Second	gal/s	Gallons/Second																																						
L/min	Liters/Minute	gal/min	Gallons/Minute																																						
L/h	Liters/Hour	gal/h	Gallons/Hour																																						
m ³ /s	Cubic Meters/Second	MG/D	MillionGallons/Day																																						
m ³ /min	Cubic Meters/Minute	IG/s	ImperialGallons/Second																																						
m ³ /h	Cubic Meters/Hour	IG/min	ImperialGallons/Minute																																						
ft ³ /s	Cubic Feet/Second	IG/h	ImperialGallons/Hour																																						
ft ³ /m	Cubic Feet/Minute	Oz/min	Ounce/Minute																																						
ft ³ /h	Cubic Feet/Hour	bbl/min	Barrel/Minute																																						
<p>Totalizer Unit</p>	<p>This parameter establishes the units of measure for the totalizers.</p> <table border="1" data-bbox="435 1747 1344 1915"> <thead> <tr> <th><i>Display</i></th> <th><i>Totalizer Unit</i></th> <th><i>Display</i></th> <th><i>Totalizer Unit</i></th> </tr> </thead> <tbody> <tr> <td>L</td> <td>Liters</td> <td>MG</td> <td>Million Gallons</td> </tr> <tr> <td>hL</td> <td>Hectoliter</td> <td>IG</td> <td>Imperial Gallons</td> </tr> <tr> <td>m³</td> <td>Cubic Meters</td> <td>bbl</td> <td>Barrel</td> </tr> <tr> <td>ft³</td> <td>Cubic Feet</td> <td>Oz</td> <td>Fluid Ounces</td> </tr> <tr> <td>gal</td> <td>U.S. Gallons</td> <td>Aft</td> <td>Acre Foot</td> </tr> </tbody> </table>	<i>Display</i>	<i>Totalizer Unit</i>	<i>Display</i>	<i>Totalizer Unit</i>	L	Liters	MG	Million Gallons	hL	Hectoliter	IG	Imperial Gallons	m ³	Cubic Meters	bbl	Barrel	ft ³	Cubic Feet	Oz	Fluid Ounces	gal	U.S. Gallons	Aft	Acre Foot																
<i>Display</i>	<i>Totalizer Unit</i>	<i>Display</i>	<i>Totalizer Unit</i>																																						
L	Liters	MG	Million Gallons																																						
hL	Hectoliter	IG	Imperial Gallons																																						
m ³	Cubic Meters	bbl	Barrel																																						
ft ³	Cubic Feet	Oz	Fluid Ounces																																						
gal	U.S. Gallons	Aft	Acre Foot																																						

MAINTENANCE

Mandatory, routine or scheduled maintenance should not be required for the M7600 Mag Meter electronics or flow tube after proper installation. However, some occurrences may require personnel to perform the following:

- Flow tube and electrode cleaning
- Circuit board replacement

⚠ WARNING

DO NOT CLEAN COMPONENTS INSIDE THE AMPLIFIER OR JUNCTION BOX.

Cleaning the Flow Tube and Electrode

At times flow tube, electrodes, amplifier/junction box housings and the amplifier window may need periodic cleaning, depending on process fluid properties, fluid flow rate and surrounding environment.

Clean the flow tube and electrodes by following the material handling and cleaning procedures documented in the Material Safety Data Sheet (MSDS) guidelines for the products(s) that were in contact with the flow tube and electrodes.

Should flow tube and/or electrode cleaning become necessary:

1. Disconnect detector from pipeline.
2. Clean electrodes according to MSDS guidelines.
3. Reconnect detector to pipeline.

Available from:  **STERLING
CONCRETE
EQUIPMENT** 937-747-4300
SterlingConcreteEquipment.com

SPECIFICATIONS

Performance

Sizes	Sizes 1/2...4 in. (15...100 mm)
Flow Range	0.14...1320 gpm (0.53...5000 lpm)
Accuracy	±0.5% of rate for velocities greater than 1.64 ft/s, ±0.008 ft/s less than 1.64 ft/s ±0.5% of rate for velocities greater than 0.50 m/s, ±2.5 mm/s less than 0.50 m/s Note: The maximum measuring error depends on the installation conditions.
Repeatability	±0.1%
Fluid Temperature	Maximum fluid temperature: 212° F (100° C)
Storage Temperature	-40...140° F (-40...60° C)
Ambient Temperature	-4...140° F (-20...60° C)
Fluid Conductivity	Minimum liquid conductivity: 5 micromhos/cm
Flow Direction	Unidirectional
Pressure Limits	Working pressure: 232 psi (16 bar)

Materials of Construction

Flow Tube	AISI 316 stainless steel
Detector Housing	Flange material: carbon steel, enamel paint finishing
Liner Material	PTFE
End Connection	ANSI 150# carbon steel flanges
Electrodes Materials	Hastelloy C22
Amplifier Housing	Powder-coated cast aluminum, NEMA 4 Meter mounted only
Cable Entries	Two 1/2 in. NPT cord grip
Grounding Rings	Standard (pre-installed)
Optional Grounding Electrodes	2

Inputs

Power Supply	92...275 VAC
Coil Excitation	Pulsed DC
Programming	PC user interface

Outputs

Digital Output	Output 1: solid-state relay up to 230V, 500 mA Output 2: Opto-isolated open collector, 50 mA at 24V DC
Frequency Output	Maximum output frequency: 10 kHz
Pulse Width	50% duty cycle

Approvals

Meter Enclosure	NEMA 4
NIST Handbook B44	Complies for batching applications

Available from:



**STERLING
CONCRETE
EQUIPMENT**

937-747-4300

SterlingConcreteEquipment.com